



sūsa

catalog 2023

setrabusa.com

Setrab

Oil Coolers

Track-proven components

Unparalleled durability, performance, and flow. It is this combination that has allowed Setrab to remain the choice of premier OEM marques as well as top teams and builders across all venues of motorsport.

Dimensional Flexibility

Setrab employs precise tooling in more sizes than any other manufacturer to allow more height/width combinations than any competitor. Most times you will find that the perfect size for your application is a stock item, ensuring immediate availability.

Brazing Technology

While competitors are brazing aluminum oil coolers merely as a method of construction, Setrab's blend of experienced craftsmen and technological methodology allow this step to afford an even greater performance advantage. Setrab oil coolers are fully-brazed using the NOCOLOK process, eliminating contact resistance or heat transfer barrier between internal components.

Internal Design

Setrab oil coolers employ in-line turbulators to gently stir the oil throughout the cooling process, ensuring that the oil has exposure to the entire internal surface area of the oil cooler with the absolute minimum pressure drop.

External Design

The air fin is the most considered and the most visible cooling portion of any oil cooler, and the Setrab fin does not disappoint. It incorporates precise mini-louvers for maximum air dissipation and is fully-brazed along the length of the oil tubes.

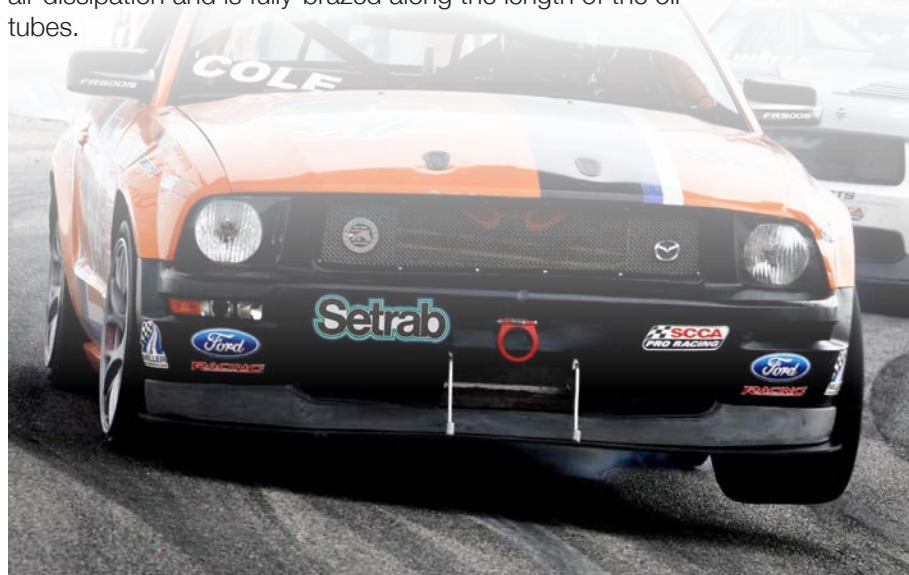
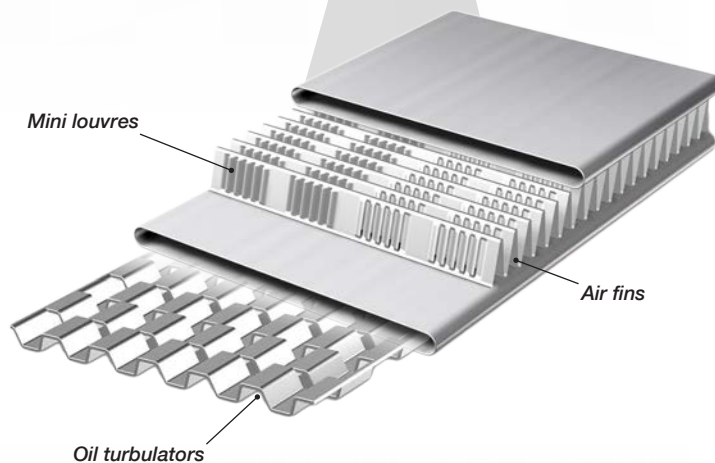
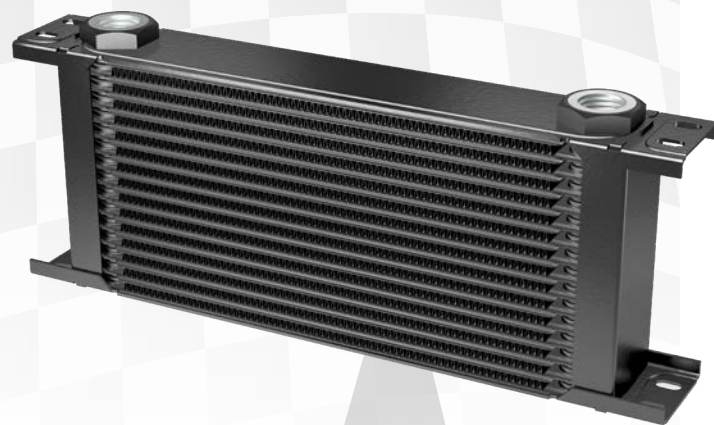

sūsa Setrab USA

The sūsa brand was born an offspring of the Setrab family — literally, Setrab USA. Now an independent innovator of oiling system components, sūsa racing parts are designed to complement and enhance the range of Setrab ProLine oil coolers with a full selection of ProLine adapter fittings & hose ends, oil control & oil access parts, filtration solutions, and a growing mix of performance plumbing components.

All sūsa racing parts are designed with the engineered balance between *performance* and *flow*, we call *HyperFlow Technology*.

ProLine STD Oil Coolers



Setrab ProLine STD range oil coolers offer unmatched performance and flow characteristics in a rugged, durable construction and wide variety of sizes.

A favorite of performance racing professionals and serious enthusiasts alike, the STD range offers the broadest selection of size and plumbing options. The low-profile M22x1.5 ProLine port make the STD range the first choice for performance cooling needs.

Detailed performance information and recommendations based on application available at: www.setrabusa.com

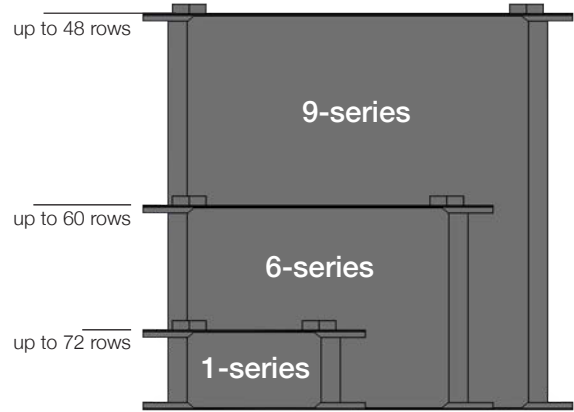

1-series width

Part no.	A	B	C	D	E	Vol. (qt.)	Wt. (lb.)
50-107-7612	6.42	2.09	4.80	7.48	8.27	0.07	0.70
50-110-7612	6.42	2.99	4.80	7.48	8.27	0.11	0.95
50-113-7612	6.42	3.94	4.80	7.48	8.27	0.15	1.15
50-116-7612	6.42	4.80	4.80	7.48	8.27	0.20	1.35
50-119-7612	6.42	5.75	4.80	7.48	8.27	0.22	1.55
50-125-7612	6.42	7.60	4.80	7.48	8.27	0.28	1.00
50-134-7612	6.42	10.39	4.80	7.48	8.27	0.43	2.70
50-144-7612	6.42	13.53	4.80	7.48	8.27	0.59	3.30
50-150-7612	6.42	15.31	4.80	7.48	8.27	0.65	3.75
50-160-7612	6.42	18.31	4.80	7.48	8.27	0.80	4.42
50-165-7612	6.42	19.89	4.80	7.48	8.27	0.85	4.60
50-172-7612	6.42	22.13	4.80	7.48	8.27	0.95	5.30

6-series width

Part no.	A	B	C	D	E	Vol. (qt.)	Wt. (lb.)
50-607-7612	11.14	2.09	9.53	12.20	12.99	0.15	1.20
50-610-7612	11.14	2.99	9.53	12.20	12.99	0.20	1.55
50-613-7612	11.14	3.94	9.53	12.20	12.99	0.25	1.90
50-616-7612	11.14	4.80	9.53	12.20	12.99	0.30	2.30
50-619-7612	11.14	5.75	9.53	12.20	12.99	0.40	2.65
50-625-7612	11.14	7.60	9.53	12.20	12.99	0.55	3.40
50-634-7612	11.14	10.39	9.53	12.20	12.99	0.75	4.50
50-640-7612	11.14	12.20	9.53	12.20	12.99	0.90	5.30
50-650-7612	11.14	15.31	9.53	12.20	12.99	1.10	6.50
50-660-7612	11.14	18.31	9.53	12.20	12.99	1.30	7.75

9-series width

Part no.	A	B	C	D	E	Vol. (qt.)	Wt. (lb.)
50-910-7612	14.09	2.99	12.48	15.16	15.94	0.25	1.95
50-915-7612	14.09	4.53	12.48	15.16	15.94	0.40	2.75
50-920-7612	14.09	6.06	12.48	15.16	15.94	0.55	3.55
50-925-7612	14.09	7.60	12.48	15.16	15.94	0.75	4.35
50-934-7612	14.09	10.39	12.48	15.16	15.94	1.00	5.85
50-948-7612	14.09	14.70	12.48	15.16	15.94	1.43	8.00
50-960-7612	14.09	18.31	12.48	15.16	15.94	1.80	9.84

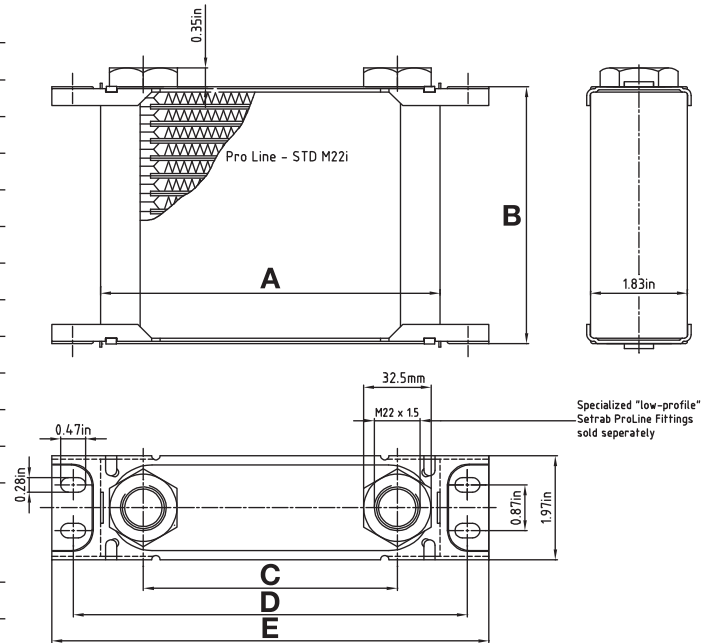

ProLine STD Multi-Pass / Specialty Oil Coolers

Setrab ProLine Multi-Pass oil coolers

Low-gpm flow-rate specialty environments such as gearboxes, differentials, and motorcycle-powered racing engines, benefit most from Setrab ProLine Multi-Pass oil coolers. Internal baffling divides the cooling rows into separate passes across the cooler.

Setrab ProLine Specialty oil coolers

High-gpm flow-rate environments of select dry-sump racing applications may require the additional flow and performance associated with Setrab ProLine Specialty coolers. The diagonal flow configuration offers the least possible resistance to oil flow, for critical applications.

Detailed performance information and recommendations based on application available at: www.setrabusa.com

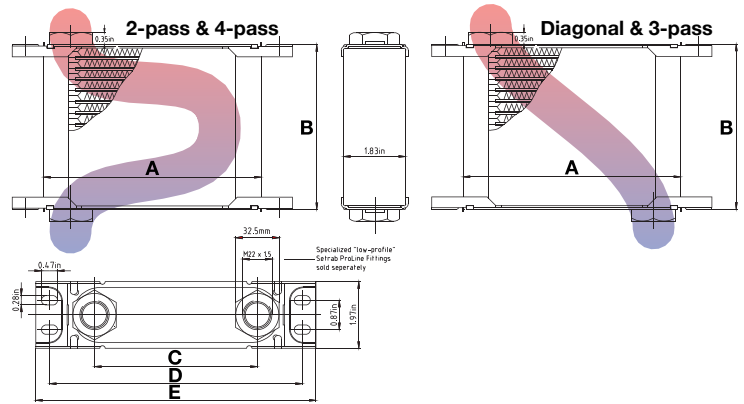

Part no.	Description	Flow	A	B	C	D	E	Vol. (qt)	Wt. (lb)
51-07943	172M221-D	Diagonal	6.42	22.13	4.80	7.48	8.27	0.95	5.30
51-15692-01	332M221 Super STD	1-pass	8.19	9.81	6.57	9.27	10.04	0.53	2.80
51-15295-01	360M221 Super STD	1-pass	8.19	18.46	6.57	9.27	10.04	1.00	5.25
51-09904-01	613M221-2P	2-pass	11.14	3.94	n/a	12.20	12.99	0.25	1.90
51-07944	619M221-2P	2-pass	11.14	5.75	n/a	12.20	12.99	0.40	2.65
51-07990	650M221-3P	3-pass	11.14	15.31	9.53	12.20	12.99	1.10	6.50
51-07945-01	920M221-2P	2-pass	14.09	6.06	n/a	15.16	15.94	0.55	3.55
51-11654-03	980M221-4P	4-pass	14.09	24.49	n/a	15.16	15.95	2.20	13.51

ProLine STD Mounting Hardware

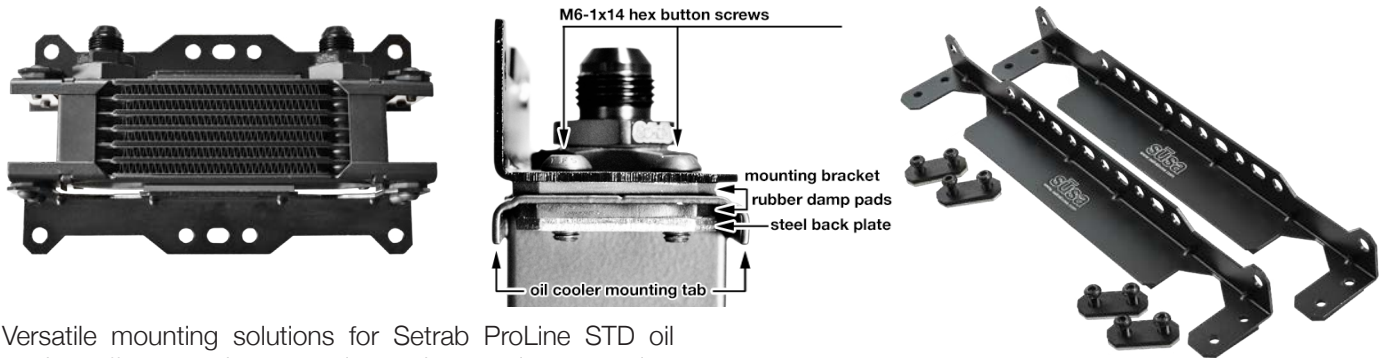

Versatile mounting solutions for Setrab ProLine STD oil coolers offer rugged construction and convenient mounting points to suit virtually any application.

Lightweight rib-reinforced brackets include rubber damping to reduce transfer of vibration to the oil cooler. The Baja-tested design integrates mounting best practices and racing circuit experience for maximum longevity.

sēsa Universal Brackets offer a variety of mounting options

Part no.	Description
23-1002	ProLine STD 1-series mounting bracket set
23-6002	ProLine STD 6-series mounting bracket set
23-9002	ProLine STD 9-series mounting bracket set
23-MPSTD-UB1-9	ProLine STD Universal Brackets
23-BPSTD	Threaded backing plate kit, 4-pack



ProLine SLM Oil Coolers



Setrab ProLine SLM range oil coolers were developed to offer the high-performing heat exchange characteristics, dimensional flexibility, and port connection adaptability of a ProLine oil cooler in a slimmed-down package, over 20% thinner than the ProLine STD. *Detailed performance information and recommendations based on application available at: www.setrabusa.com*

14 ROW
10 ROW
6 ROW

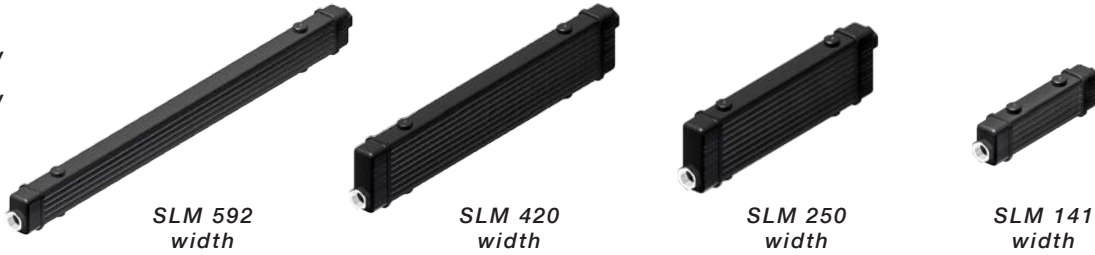

Part no.	Description	Length		Height		Depth	O/C Mounts	Capacities	
		Core	Overall	Core	Overall			M6x1.0	Vol. (qt)
53-10740-01	SLM 141, 6 rows	5.55	8.03	2.05	2.52	1.57	3.54	0.16	0.60
53-10741-01	SLM 141, 10 rows	5.55	8.31	3.46	3.94	1.57	3.54	0.25	0.90
53-10742-01	SLM 141, 14 rows	5.55	8.31	4.88	5.43	1.57	3.54	0.38	1.20
53-10743-01	SLM 250, 6 rows	9.84	12.32	2.05	2.52	1.57	7.87	0.20	0.85
53-10744-01	SLM 250, 10 rows	9.84	12.60	3.50	4.06	1.57	7.87	0.31	1.30
53-10745-01	SLM 250, 14 rows	9.84	12.60	4.88	5.43	1.57	7.87	0.50	1.70
53-10746-01	SLM 420, 6 rows	16.54	19.02	2.09	2.64	1.57	12.60	0.25	1.30
53-10747-01	SLM 420, 10 rows	16.54	19.29	3.50	4.06	1.57	12.60	0.38	1.90
53-10748-01	SLM 420, 14 rows	16.54	19.29	4.88	5.43	1.57	12.60	0.63	2.55
53-15560-01	SLM 420, 14 rows 2-pass	16.54	19.29	4.88	5.43	1.57	12.60	0.63	2.55
53-10749-01	SLM 592, 6 rows	23.31	25.79	2.09	2.64	1.57	19.37	0.31	1.70
53-10750-01	SLM 592, 10 rows	23.31	26.06	3.50	4.06	1.57	19.37	0.50	2.55
53-10751-01	SLM 592, 14 rows	23.31	26.06	4.88	5.43	1.57	19.37	0.75	3.35

ProLine COM Oil Coolers

Setrab ProLine COM oil coolers offer unique & versatile plumbing opportunities in a heavy-duty high-performance build.

Part no.	Description	Length		Height		Depth	O/C Mounts	Capacities	
		Core	Overall	Core	Overall			M8x1.25	Vol. (qt)
52-12864-01	COM-F 528, 15 rows	20.88	23.50	5.25	5.88	1.88	16.88	1.10	6.15
52-12965-01	COM-F 528, 15 rows, 2P	20.88	23.50	5.25	5.88	1.88	16.88	1.10	6.15
52-12968-01	COM-V 586, 5 rows, 2P	23.07	26.22	3.03	3.15	2.80	19.13	0.88	4.90
52-13141-01	COM-F 464, 12 rows, 2P	18.27	20.94	4.22	4.77	1.97	19.61	0.99	5.50



52-12968-01



52-12864-01



52-13141-01



52-12965-01

ProLine STD Fanpacks

Setrab ProLine Fanpacks combine the already high-performing and versatile heat exchange characteristics of the range of Setrab ProLine STD oil coolers with high-volume, low-profile fans and robust fan shrouds to create a cooling package that is unparalleled in performance and versatility.

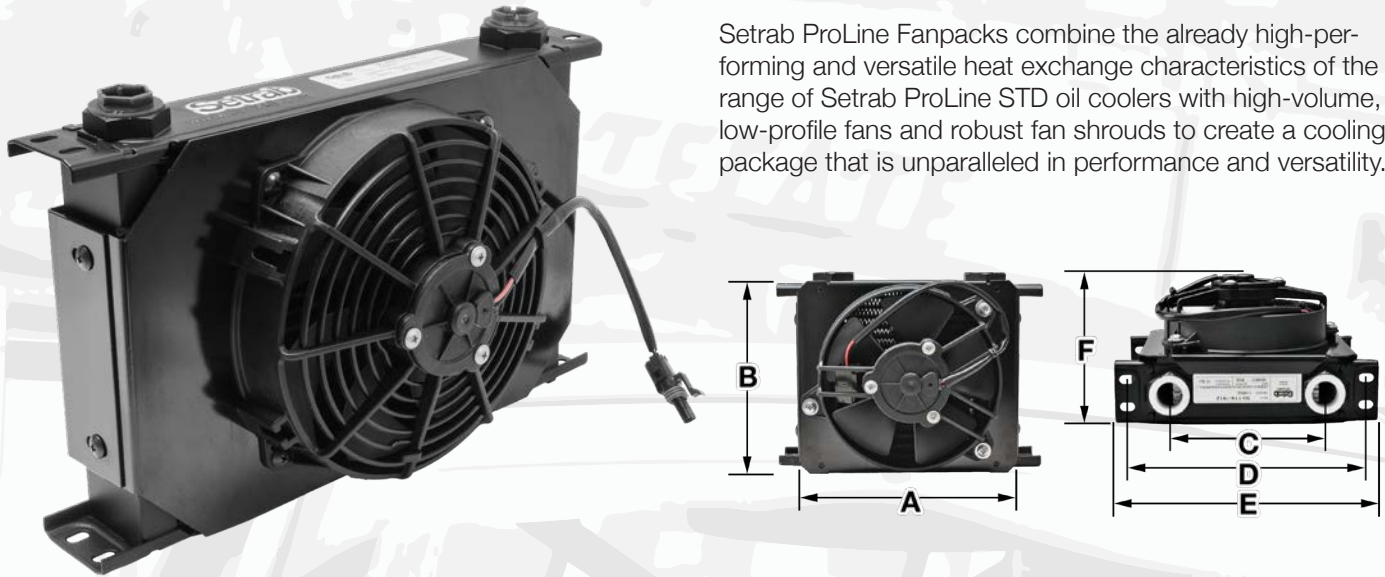

Part no.	Description		Dimensions								Vol. (qt)	Wt. (lb)
	Oil Cooler(s)	Fan(s)	A	B	C	D	E	F				
FP113M22I	STD 1-series, 13-row	12V, 150 cfm	6.50	3.94	4.80	7.48	8.27	4.38	0.15	2.85		
FP119M22I	STD 1-series, 19-row	12V, 342 cfm	6.50	5.75	4.80	7.48	8.27	5.50	0.22	3.55		
FP160M22I	STD 1-series, 60-row	3x 12V, 1026 cfm	6.50	18.31	4.80	7.48	8.27	5.50	0.80	13.50		
FP332 SSTD	Super STD 3-series, 32-row	12V, 331 cfm	8.60	9.75	6.57	9.27	10.04	4.38	0.53	5.50		
FP360 SSTD	Super STD 3-series, 60-row	2x 12V, 662cfm	8.60	18.54	6.57	9.27	10.04	4.38	1.00	11.20		
FP625M22I	STD 6-series, 25-row	12V, 331 cfm	11.38	7.60	9.53	12.20	12.99	4.38	0.55	5.85		
FP634M22I	STD 6-series, 34-row	12V, 708 cfm	11.38	10.25	9.53	12.20	12.99	4.38	0.75	8.95		
FP650M22I	STD 6-series, 50-row	2x 12V, 662 cfm	11.38	15.31	9.53	12.20	12.99	4.38	1.10	11.40		
FP910M22IX2	2x STD 9-series, 10 row	2x 12V, 684 cfm	14.50	6.00	12.48	15.16	16.00	5.50	0.25/ea	7.55		
FP920M22I	STD 9-series, 20-row	2x 12V, 684 cfm	14.50	6.00	12.48	15.16	16.00	5.50	0.55	7.20		
FP920M22I-2P	STD 9-series, 20-row, 2P	2x 12V, 684 cfm	14.50	6.00	N/A	15.16	16.00	5.50	0.55	7.25		
FP948M22I	STD 9-series, 48-row	12V, 1242 cfm	14.50	15.13	12.48	15.16	16.00	4.75	1.43	15.15		
FP980M22I-4P	STD 9-series, 80-row, 4P	2x 12V, 3568 cfm	14.50	25.50	N/A	15.16	16.00	4.75	2.20	22.00		

ProLine STD Fan Kits

Setrab ProLine Fan Kits include fans and fan-mounting hardware to convert select sizes of ProLine STD oil coolers into Fanpacks.

Part no.	Fits ProLine STD oil cooler size:	Fan(s)
FP113KIT	50-113-7612	12V, 150 cfm
FP119KIT	50-119-7612, 3x on 50-160-7612	12V, 342 cfm
FP332KIT	Super STD 332	12V, 331 cfm
FP360KIT	Super STD 360	2x 12V, 662 cfm
FP625KIT	50-625-7612, 2x on 50-650-7612	12V, 331 cfm
FP634KIT	50-634-7612	12V, 708 cfm
FP920KIT	50-920-7612, 920M22I-2P	2x 12V, 684 cfm
FP948KIT	50-948-7612	12V, 1242 cfm
FP980KIT	51-11654-03 (980M22I-4P)	2x 12V, 3568 cfm



Pumps Mini Gear Oil Circulation Pumps



The sūsa mini gear oil circulation pump is a 12V positive displacement pump with no internal bypass. Typical applications are differential/gearbox cooling circuits.

This self-priming pump is designed to circulate oil and water-based fluids, features bronze helical gears and nickel-plated brass pump head. Rated IP-67 for all-weather performance.

Compact, lightweight, and durable, the sūsa oil circulation pump complements the entire range of sūsa differential/gearbox cooling components, creating a high-performance systems solution.



Pump Specifications	
Ports	3/8" BSPP
Max. work pressure	22 psi
Max. work temp.	Tested to 250 °F
Flow rate	0.9 gpm (1/2" ID hose)
Self priming	5 ft (wet gears)
Compatible fluids	Oil with viscosity < 350 cSt
Pump head	Brass, nickel-plated
Gears	Bronze, helical
Motor	12 V with stainless-steel shaft and fluoroelastomer lip seal, rated IP-67
Amperage draw	2.5 A / 12 V
Weight	2.6 lb without fittings or filter

More details available: www.setrabusa.com

Fitting	Filter	Part no.
None	None	17-311-00-0005
-6	None	17-311-06-0005
	150 μ	17-311-06-IF05
-8	None	17-311-08-0005
	150 μ	17-311-08-IF05
-10	None	17-311-10-0005
	150 μ	17-311-10-IF05

Electrical Switches & Relays

sūsa thermal switches install directly in the oil line and provide an automatic switch to turn on an electric fan or electric external differential/transmission pump.

Switch Specifications	
Contact type	Normally open
Action temp.	Nominal ± 3.6 °F
Auto reset temp.	Nominal -15 ± 3.6 °F
Terminal size	Amp #250 tab
Operating life	100,000 cycles: 15A 125VAC / 10A 250VAC

More details available: www.setrabusa.com



Temp.	Size	Part no.
● 180 °F	-6	31-TS180-06
	-8	31-TS180-08
	-10	Assembly 31-TS180-10
	-12	31-TS180-12
	-16	31-TS180-16
	NPT 1/8"	Probe TS180
● 190 °F	-6	31-TS190-06
	-8	31-TS190-08
	-10	Assembly 31-TS190-10
	-12	31-TS190-12
	-16	31-TS190-16
	NPT 1/8"	Probe TS190
● 200 °F	-6	31-TS200-06
	-8	31-TS200-08
	-10	Assembly 31-TS200-10
	-12	31-TS200-12
	-16	31-TS200-16
	NPT 1/8"	Probe TS200
Relay	30A 5-pin Bosch style	31-R30A-5P

ProLine Oil Filter Adapters



sūsa HyperFlow Sandwich Adapter

Built to perform from street to track, the HyperFlow Sandwich Adapter provides easy access for performance plumbing needs. Designed for performance, reliability, and integration with sūsa ProLine adapter fitting system.

Thermostat	Mfg type	Filter thread	Part no.
None	Cast	M20x1.5	19-SP76-20-22
		M22x1.5	19-SP76-22-22
		3/4"-16	19-SP76-34-22
Built-in, 180°F	Cast	M20x1.5	19-SPT76-20-180-22
		M22x1.5	19-SPT76-22-180-22
		3/4"-16	19-SPT76-34-180-22
Built-in, 180°F	Billet	M20x1.5	19-SPTB76-20-180-22
		M22x1.5	19-SPTB76-22-180-22
		3/4"-16	19-SPTB76-34-180-22



Oil Filter Spacer

Designed for vehicles with a recessed oil filter landing.

Oil Filter Thread	Part no.
M20x1.5	19-SPS76-20
M22x1.5	19-SPS76-22
3/4"-16	19-SPS76-34



Sandwich Adapter with Oil Filter Spacer			
None	Cast		19-SP76-F86-22
Built-in, 180°F	Cast	M20x1.5	19-SPT76-F86-180-22
	Billet		19-SPTB76-F86-180-22



Take-off for LS motors

Designed to access oil supply on LS motors to install an oil cooler. Features M22 ports for sūsa ProLine adapter fittings (sold separately).

Thermostat	Part no.
None	18-TOLS-22
Built-in, 180°F	18-TOTLS-22

Pictured: 18-TOTLS-22 thermostatic-controlled (fittings not included)



Spin-on Filter Take-off & In-line Oil Thermostat

- Billet aluminum & durable anodizing
- sūsa ProLine ports

Filter thread	Part no.
13/16"-16	18-TOP76-13-22
M20x1.5	18-TOP76-20-22
M22x1.5	18-TOP76-22-22
3/4"-16	18-TOP76-34-22
In-line 180°F	40-AOT180-22-B

Remote Oil Filter Stand

sūsa billet remote oil filter stands with ProLine ports are machined to suit a wide range of spin-on oil filter sizes.

Some models include built-in oil thermostat in various flow directions (see table) for convenient plumbing.



Filter Landing ID	Filter Landing OD	Thermostat	Oil Filter Thread	Part no.
54mm	77mm	None	13/16"-16	18-RFHU77-13-22
			M20x1.5	18-RFHU77-20-22
			M22x1.5	18-RFHU77-22-22
70mm	92mm	None	3/4"-16	18-RFHU77-34-22
			13/16"-16	18-RFHU92-13-22
			M20x1.5	18-RFHU92-20-22
			M22x1.5	18-RFHU92-22-22
			3/4"-16	18-RFHU92-34-22

Filter Landing ID	Filter Landing OD	Thermostat	Flow Direction	Oil Filter Thread	Part no.
54mm	77mm	180°F	Left to Right	13/16"-16	18-RFHUT77-13-22-LTR
				M20x1.5	18-RFHUT77-20-22-LTR
				M22x1.5	18-RFHUT77-22-22-LTR
			Right to Left	3/4"-16	18-RFHUT77-34-22-LTR
				13/16"-16	18-RFHUT77-13-22-RTL
				M20x1.5	18-RFHUT77-20-22-RTL
			M22x1.5	18-RFHUT77-22-22-RTL	
			3/4"-16	18-RFHUT77-34-22-RTL	

**filters better
flows better**

lasts forever



HyperFlow Engine Oil Filter

Engineered to balance performance and flow for your street or track vehicle.

High flow volume, low pressure drop, 30 μ absolute filtration, and a strong rare-earth magnet combine to deliver unmatched performance and protection. The *HyperFlow* Oil Filter's surgical-grade stainless-steel mesh media filter element captures all particulates above 30 μ , leaving no doubt about the oil reaching your engine.

The improved flow characteristics of the *HyperFlow* Oil Filter reduce restrictions on the oiling system—meaning less power is spent pumping oil and more power reaches the wheels.



A cleanable filter element offers convenience and longevity. Precision CNC-machined billet aluminum body with titanium-color anodized finish offers a knurled non-slip grip surface and a hex boss for easy removal.

Disassembles by hand — simply push the filter element into the body and twist to remove, clean, and reuse.

Filtration	Threaded base		
	Thread	Color	Part no.
30 μ	13/16"-16	red	11-RU77-13
	M20x1.5	silver	11-RU77-20
	M22x1.5	blue	11-RU77-22
	3/4-16	silver	11-RU77-34
Gasket Service Kit			11-SKRU77



In-Line Pre-Filters

Install directly in the oil line before an external differential or transmission cooling circuit pump.

Cleanable/replaceable 150 μ filter element with strong rare-earth magnet offers convenience and longevity.

Filtration	AN size	Part no.
150 μ	-6	11-IF0606-D
	-8	11-IF0808-D
	-10	11-IF1010-D
	-12	11-IF1212-D
In-Line Pre-Filter Service Kit		11-SKIF612



Adapter Fitting Pre-Filters

Install directly between AN adapter fittings and hose ends.

Easy to install, easy to access, easy to clean and reuse.

Filtration	AN size	Part no.
250 μ	-6	11-UF06
	-8	11-UF08
	-10	11-UF10
	-12	11-UF12
	-16	11-UF16

ProLine Direct-Port Adapter System



Setrab pioneered the direct-port oil cooler fitting with its ProLine program, providing the highest-quality connection and an unparalleled adaptability.

The simplest possible connection — 1 fitting to hose — delivers reliable, performance plumbing, saves space in crowded engine bays, and keeps a clean, consistent style.

The ProLine port offers M22x1.5 thread with a flat-face port, and all ProLine fittings capture the o-ring under the hex in a chamfered groove, for smooth, positive sealing.

ProLine AN Adapter Fittings

Angle	AN size	Part no.
00°	-4	22-M22AN04-SE
	-6	22-M22AN06-SE
	-8	22-M22AN08-SE
	-10	22-M22AN10-SE
	-12	22-M22AN12-SE
45°	-16	22-M22AN16-SE
	-6	22-M22AN06-45
	-8	22-M22AN08-45
	-10	22-M22AN10-45
90°	-12	22-M22AN12-45
	-6	22-M22AN06-90
	-8	22-M22AN08-90
	-10	22-M22AN10-90
	-12	22-M22AN12-90



ProLine Banjo AN Adapter Fittings

The tightest, lowest 90° turn possible on Setrab ProLine oil coolers.

Angle	AN size	Part no.
90°	-6	22-M22BJAN06-90
	-8	22-M22BJAN08-90
	-10	22-M22BJAN10-90
	-12	22-M22BJAN12-90
	Service Kit	22-SKBJM22



ProLine Port Adapter

A unique design with a multitude of applications. Adapts ProLine port 90°, swivels 360°, includes gauge port for NPT accessories.

Angle	Port 1	Port 2	Part no.
90°	M22	1/8" NPT	22-M22-90-NPT18

ProLine PushLock Hose Ends

Use with sūsa 21-PLN hose

Angle	AN size	Part no.
00°	-6	22-M22PL06-00
	-8	22-M22PL08-00
	-10	22-M22PL10-00
	-12	22-M22PL12-00
45°	-6	22-M22PL06-45
	-8	22-M22PL08-45
	-10	22-M22PL10-45
90°	-12	22-M22PL12-45
	-6	22-M22PL06-90
	-8	22-M22PL08-90
120°	-10	22-M22PL10-90
	-12	22-M22PL12-90
	-8	22-M22PL08-120



ProLine ReUsable Hose Ends

Use with sūsa 21-LWN & 21-SSN hose

Angle	AN size	Part no.
00°	-6	22-M22RU06-00
	-8	22-M22RU08-00
	-10	22-M22RU10-00
	-12	22-M22RU12-00
45°	-6	22-M22RU06-45
	-8	22-M22RU08-45
	-10	22-M22RU10-45
90°	-12	22-M22RU12-45
	-6	22-M22RU06-90
	-8	22-M22RU08-90
120°	-10	22-M22RU10-90
	-12	22-M22RU12-90
	-8	22-M22RU08-120



ProLine Adapters BSP / Metric / Wiggins



ProLine BSP Adapter Fittings

Angle	BSP size	Part no.
00°	3/8"	22-M22BSP38-00
	1/2"	22-M22BSP12-00
	5/8"	22-M22BSP58-00
	3/4"	22-M22BSP34-00



ProLine Wiggins Adapter Fittings

Tube size	Wiggins	Part no.
1/2"	-8	22-M22WGN08-00
5/8"	-10	22-M22WGN10-00
3/4"	-12	22-M22WGN12-00
1"	-16	22-M22WGN16-00



ProLine Metric Adapter Fittings

Angle	Metric size	Part no.
00°	M26	22-M22M26-SE
	M30	22-M22M30-SE



ProLine Bushings

Male end	Port size	Part no.
M22	1/8" NPT	22-M22NPT18
	M18	22-M22M18
	M16	22-M22M16
	M14	22-M22M14



Plugs

Fittings	Part no.
M22x1.5	22-M22



Assembly Lubricant

For smooth assembly of ProLine fittings and hose ends.

Description	Part no.
Assembly lube 0.5mL	20-042368

O-rings for ProLine M22 fittings

Description	Part no.
ProLine O-rings 10pcs	20-568019-V-10

AN Adapters BSP / Metric / ORB

ORB AN Adapters (O-ring included)

Angle	ORB size	AN size	Part no.
-6	-6	-6	22-ORB06AN06-00
		-8	22-ORB06AN08-00
	-8	-6	-6
-8			22-ORB08AN08-00
-10		-10	22-ORB08AN10-00
00°	-6	-6	22-ORB10AN06-00
		-8	22-ORB10AN08-00
	-10	-10	22-ORB10AN10-00
		-12	22-ORB10AN12-00
		-8	22-ORB12AN08-00
-12	-10	22-ORB12AN10-00	
	-12	22-ORB12AN12-00	



ORB Port Plugs

ORB size	Part no.
-6	22-ORB06
-8	22-ORB08
-10	22-ORB10
-12	22-ORB12

Metric AN Adapters

Angle	Metric size	AN size	Part no.
	M14	-6	22-M14AN06-00
		-8	22-M14AN08-00
00°	M16	-6	22-M16AN06-00
		-8	22-M16AN08-00
	M18	-6	22-M18AN06-00
-8		22-M18AN08-00	
-10		22-M18AN10-00	
-8		22-M20AN08-00	
	M20	-10	22-M20AN10-00
		-12	22-M20AN12-00



BSP AN Adapters

Angle	BSP size	AN size	Part no.
3/8"	-6	-6	22-BSP38AN06-00
		-8	22-BSP38AN08-00
		-10	22-BSP38AN10-00
00°	-6	-6	22-BSP12AN06-00
		-8	22-BSP12AN08-00
	1/2"	-10	22-BSP12AN10-00
		-12	22-BSP12AN12-00

Dowty Seals Bonded Washers

DS size	Use with	Part no.
13/16"	1/2" BSP	22-DS1316
M14	M14	22-DSM14
M16	M16	22-DSM16
M18	M18	22-DSM18
M20	M20	22-DSM20
M22	M22	22-DSM22
M24	M24	22-DSM24



AN Hose Ends PushLock / ReUsable

Complete your plumbing project by matching sūsa direct-port fittings, hose ends, and adapters. Create a consistent look in your lines with a complementary form to equal superior build and performance.

AN PushLock Hose Ends

Use with sūsa 21-PLN hose



Angle	AN size	Part no.
00°	-6	22-AN06PL06-00
	-8	22-AN08PL08-00
	-10	22-AN10PL10-00
	-12	22-AN12PL12-00
30°	-6	22-AN06PL06-30
	-8	22-AN08PL08-30
	-10	22-AN10PL10-30
	-12	22-AN12PL12-30
45°	-6	22-AN06PL06-45
	-8	22-AN08PL08-45
	-10	22-AN10PL10-45
	-12	22-AN12PL12-45
60°	-6	22-AN06PL06-60
	-8	22-AN08PL08-60
	-10	22-AN10PL10-60
	-12	22-AN12PL12-60
90°	-6	22-AN06PL06-90
	-8	22-AN08PL08-90
	-10	22-AN10PL10-90
	-12	22-AN12PL12-90
120°	-6	22-AN06PL06-120
	-8	22-AN08PL08-120
	-10	22-AN10PL10-120
	-12	22-AN12PL12-120
150°	-6	22-AN06PL06-150
	-8	22-AN08PL08-150
	-10	22-AN10PL10-150
	-12	22-AN12PL12-150
180°	-6	22-AN06PL06-180
	-8	22-AN08PL08-180
	-10	22-AN10PL10-180
	-12	22-AN12PL12-180

AN Fitting Caps

Aluminum, anodized black



AN size	Part no.
-6	22-AN06
-8	22-AN08
-10	22-AN10
-12	22-AN12
-16	22-AN16

AN ReUsable Hose Ends

Use with sūsa 21-LWN & 21-SSN hose



Angle	AN size	Part no.
00°	-6	22-AN06RU06-00
	-8	22-AN08RU08-00
	-10	22-AN10RU10-00
	-12	22-AN12RU12-00
30°	-6	22-AN06RU06-30
	-8	22-AN08RU08-30
	-10	22-AN10RU10-30
	-12	22-AN12RU12-30
45°	-6	22-AN06RU06-45
	-8	22-AN08RU08-45
	-10	22-AN10RU10-45
	-12	22-AN12RU12-45
60°	-6	22-AN06RU06-60
	-8	22-AN08RU08-60
	-10	22-AN10RU10-60
	-12	22-AN12RU12-60
90°	-6	22-AN06RU06-90
	-8	22-AN08RU08-90
	-10	22-AN10RU10-90
	-12	22-AN12RU12-90
120°	-6	22-AN06RU06-120
	-8	22-AN08RU08-120
	-10	22-AN10RU10-120
	-12	22-AN12RU12-120
150°	-6	22-AN06RU06-150
	-8	22-AN08RU08-150
	-10	22-AN10RU10-150
	-12	22-AN12RU12-150
180°	-6	22-AN06RU06-180
	-8	22-AN08RU08-180
	-10	22-AN10RU10-180
	-12	22-AN12RU12-180

Adapters Couplers / Bulkhead / Bushings

AN Unions & Reducers

Angle	Side 1	Side 2	Part no.
-------	--------	--------	----------

Female – Female

00°	-6	-6	22-AN06FAN06F-00
	-8	-8	22-AN08FAN08F-00
00°	-8	-6	22-AN08FAN06F-00
	-10	-10	22-AN10FAN10F-00
00°	-10	-8	22-AN10FAN08F-00
	-12	-12	22-AN12FAN12F-00
90°	-12	-10	22-AN12FAN10F-00
	-6	-6	22-AN06FAN06F-90
90°	-8	-8	22-AN08FAN08F-90
	-10	-10	22-AN10FAN10F-90
90°	-12	-12	22-AN12FAN12F-90

Female – Male

00°	-8	-6	22-AN08FAN06M-00
	-10	-8	22-AN10FAN08M-00
	-12	-10	22-AN12FAN10M-00
00°	-16	-12	22-AN16FAN12M-00

Male – Male

00°	-6	-6	22-AN06MAN06M-00
	-6	-5	22-AN06MAN05M-00
	-4	-4	22-AN06MAN04M-00
00°	-8	-8	22-AN08MAN08M-00
	-8	-6	22-AN08MAN06M-00
	-10	-10	22-AN10MAN10M-00
00°	-10	-8	22-AN10MAN08M-00
	-6	-6	22-AN10MAN06M-00
	-12	-12	22-AN12MAN12M-00
00°	-12	-10	22-AN12MAN10M-00
	-8	-8	22-AN12MAN08M-00
	-16	-16	22-AN16MAN16M-00
00°	-16	-12	22-AN16MAN12M-00
	-10	-10	22-AN16MAN10M-00

Bushings

Male end	Port size	Part no.
M12	1/8" NPT	22-M12NPT18
M14	1/8" NPT	22-M14NPT18
M16	M12	22-M16M12
	1/8" NPT	22-M16NPT18
M22	1/8" NPT	22-M22NPT18
	M18	22-M22M18
	M16	22-M22M16
3/8" NPT	M14	22-M22M14
	1/4" NPT	22-NPT38NPT14
1/4" NPT	1/8" NPT	22-NPT38NPT18
	1/8" NPT	22-NPT14NPT18

AN Bulkhead Assemblies w/nut

Angle	AN size	Part no.
-------	---------	----------

00°	-6	22-AN06BHAN06-00
	-8	22-AN08BHAN08-00
	-10	22-AN10BHAN10-00
	-12	22-AN12BHAN12-00
45°	-16	22-AN16BHAN16-00
	-6	22-AN06BHAN06-45
	-8	22-AN08BHAN08-45
	-10	22-AN10BHAN10-45
90°	-12	22-AN12BHAN12-45
	-16	22-AN16BHAN16-45
	-6	22-AN06BHAN06-90
	-8	22-AN08BHAN08-90
90°	-10	22-AN10BHAN10-90
	-12	22-AN12BHAN12-90
	-16	22-AN16BHAN16-90

NPT AN Adapters

Angle	NPT size	AN size	Part no.
-------	----------	---------	----------

00°	1/8"	-6	22-NPT18AN06-00
	1/4"	-6	22-NPT14AN06-00
00°	1/4"	-8	22-NPT14AN08-00
	3/8"	-6	22-NPT38AN06-00
00°	3/8"	-8	22-NPT38AN08-00
	1/2"	-10	22-NPT38AN10-00
00°	1/2"	-8	22-NPT12AN08-00
	3/4"	-10	22-NPT12AN10-00
00°	3/4"	-12	22-NPT12AN12-00
	1 1/4"	-8	22-NPT34AN08-00
00°	1 1/4"	-10	22-NPT34AN10-00
	1 1/2"	-12	22-NPT34AN12-00
00°	1 1/2"	-16	22-NPT34AN16-00

NPS AN Adapters

Specialty Transmission Fittings

NPT size	AN size	Part no.
----------	---------	----------

1/4"	-6	22-NPSM14AN06-00
	-8	22-NPSM14AN08-00
1/2"	-6	22-NPSM12AN06-00
	-8	22-NPSM12AN08-00

NPT Pipe Plugs

NPT size	Part no.
----------	----------

1/8"	22-NPT18
1/4"	22-NPT14
3/8"	22-NPT38
1/2"	22-NPT12
3/4"	22-NPT34

Adapters Tube Adapters & Specialty Fittings

Hard Line Tube Adapters

Easily access the oil supply on vehicles with hard lines with hard line tube adapters.

Tube Nut & Sleeve Assemblies



Hose end sold separately

Requires flaring hard line to accept/retain sleeve, converts to AN connection.

Tube size	AN size	Part no.
5/16"	-6 Female	22-TN05
3/8"	-6 Female	22-TN06
1/2"	-8 Female	22-TN08
5/8"	-10 Female	22-TN10
3/4"	-12 Female	22-TN12



In-Line Barbed Gauge Adapter

Port	Fitting size	Part no.
1/8" NPT	3/8" (-6)	22-PO3838-NPT18T



In-Line AN Swivel Gauge Adapters

Port	AN size	Part no.
	-6	22-AN06AN06-NPT18T
	-8	22-AN08AN08-NPT18T
1/8" NPT	-10	22-AN10AN10-NPT18T
	-12	22-AN12AN12-NPT18T
	-16	22-AN16AN16-NPT18T

Cushion Clamps



Securely fastening your high-performance sūsa oil hose with our cushioned clamps tidies up your engine bay and reduces potential for vibration transferring into brazed aluminum oil cooler through the hose.

Hose size	Part no.
-6	21-PC06
-8	21-PC08
-10	21-PC10
-12	21-PC12

- Convert hard lines to AN fittings, male & female
- Sold as assemblies with adapters & sleeve or olive
- Aluminum anodized black

Tube Adapter Assemblies



Tube size	AN size	Part no.
5/16"	Male	22-TU31AN06-00
	Female	22-TU31AN06F-00
3/8"	Male	22-TU38AN06-00
	Female	22-TU38AN06F-00
1/2"	Male	22-TU12AN08-00
	Female	22-TU12AN08F-00
5/8"	Male	22-TU58AN10-00
	Female	22-TU58AN10F-00
3/4"	Male	22-TU34AN12-00
	Female	22-TU34AN12F-00

Hose Separators



sūsa Hose Separators keep your oil flexible lines separated and provide extra structure in a sleek and

minimal form.

Machined from lightweight billet aluminum and anodized either bright silver or matte black, these items install in a snap.

Color	Hose size	Part no.
Black	-6	22-HS06-BK
	-8	22-HS08-BK
	-10	22-HS10-BK
	-12	22-HS12-BK
Silver	-6	22-HS06-SI
	-8	22-HS08-SI
	-10	22-HS10-SI
	-12	22-HS12-SI



Specialty Fittings



Side 1	Side 2	Part no.
M30 fem	-12 AN male	22-M30FAN12M-00
	-16 AN male	22-M30FAN16M-00

ProLine Performance Hose

Regardless of the system, there is a high-quality ProLine hose for any performance lubricating or plumbing application. Match sūsa ReUsable hose ends with ultra-durable braided hose options, or sūsa PushLock hose ends with PushLite performance hose.

- Braided outer jacket in stainless-steel or lightweight fiber
- CPE or elastomer inner tube with reinforcing inner braid
- Continuous operating temperature from -40°F–300°F
- Suitable for fuel, oil, coolant, and air
- Available in precut lengths: 3, 6, 12, 24, 48, or custom length >60
- For more information, visit: www.setrabusa.com

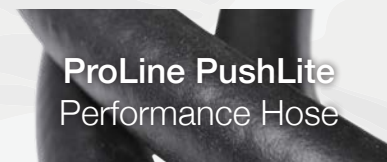
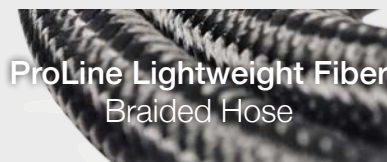
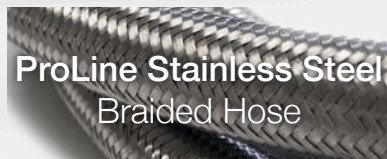

Type	Dash Size	ID		Max. Op.	Min. Bend	Wt / ft	Vacuum	Volume	Part no.
		in	in	Pressure	Radius				
SSN	-6	0.34	0.55	1000	2.50	0.16	21	0.60	21-SSN06-B
	-8	0.44	0.65	1000	3.50	0.17	21	1.01	21-SSN08-B
	-10	0.56	0.80	750	4.00	0.21	28	1.64	21-SSN10-B
	-12	0.69	0.94	750	4.50	0.29	28	2.49	21-SSN12-B
	-16	0.88	1.15	750	5.50	0.38	21	4.05	21-SSN16-B
LWN	-6	0.34	0.55	1000	2.50	0.08	21	0.60	21-LWN06-B
	-8	0.44	0.65	1000	3.50	0.09	21	1.01	21-LWN08-B
	-10	0.56	0.80	750	4.00	0.14	28	1.64	21-LWN10-B
	-12	0.69	0.94	750	4.50	0.16	28	2.49	21-LWN12-B
	-16	0.88	1.15	750	5.50	0.20	21	4.05	21-LWN16-B
PLN	-6	0.38	0.63	250	3.0	0.13	28	0.75	21-PLN06-B
	-8	0.50	0.75	250	5.0	0.15	28	1.31	21-PLN08-B
	-10	0.63	0.94	250	6.0	0.22	18	2.07	21-PLN10-B
	-12	0.75	1.00	250	7.0	0.26	18	2.94	21-PLN12-B



AN Dry-Break Fittings

Dry-break fittings offer the ultimate convenience for clean and quick changeover of fluid system components.

Internal Viton seals enable smooth 360° swivel between the AN connection and the bayonet dry-break mechanism, ensuring the threaded AN connections remain tight while engaging or disengaging dry-break components.



AN Size	Part no.
-6	13-DB-HF1-0606-A-B
-8	13-DB-HF1-0808-A-A
-10	13-DB-HF1-1010-A-B
-12	13-DB-HF1-1212-A-A



Oil Coolers



Setrab USA

24 South Clayton Street
Centerburg, Ohio 43011
info@setrabusa.com
+1 740 625 6228

www.setrab**usa**.com

The sūsa brand was born an offspring of the Setrab family — literally, Setrab USA. Now an independent innovator of oiling system components, sūsa racing parts are designed to complement and enhance the range of Setrab ProLine oil coolers with a full selection of ProLine adapter fittings & hose ends, oil control & oil access parts, filtration solutions, and a growing mix of performance plumbing components.

All sūsa racing parts are designed with the engineered balance between *performance* and *flow*, we call *HyperFlow Technology*.

Bespoke manufacturing

Leveraging broad production capabilities and experience with economies of scale, we are happy to offer bespoke manufacturing as a service.

Utilizing assets in-house and those of trusted partners to bridge gaps with custom-made parts in many projects, this program now has a life of its own.

Whether small batch, project, or production-run, ask us if we can make it, and, chances are – we can!

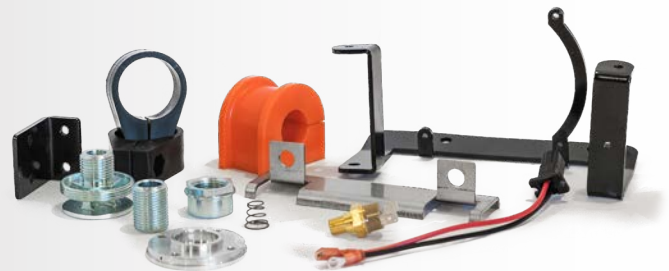

- adapters & fittings
- wiring harnesses
- thermal switches
- CNC components
- custom bolts
- custom brackets
- shrouds
- urethane bushings
- injection molding
- metal finishing
- thermoforming
- extrusions